

Before Initial Use

CONGRATULATIONS on your purchase of a top-quality Water Tech product which has been thoroughly tested to meet our exacting quality control standards.

State of the art Nickel-Metal Hydride batteries power the Pool Blaster. These are the same batteries used in many portable phones. In order to properly ventilate and cool the batteries and drive system a certain amount of space is left open in the Pool Blaster body. As a result, from time to time, water may enter the unit. In order to allow for any water to be drained you should remove the On-Off Knob after each use, turn the machine so the knob is towards the floor and tilt side to side in all directions. The amount of water may be very small or not noticed at all. After removing any water use a blow dryer on warm setting to dry any moisture build-up on the inside of the motor box. Water entering the Pool Blaster body presents no safety hazard and should be drained occasionally to avoid any chance of long-term corrosion. The batteries and motor in the Pool Blaster are long lasting and proper care will help to prolong the life of your appliance.

These guidelines and safeguards help insure that your new Pool Blaster operates effectively. Please read all instructions carefully before using your Pool Blaster. Please take a few moments to review the following IMPORTANT INFORMATION before using this tool.

















READ ALL INSTRUCTIONS CAREFULLY BEFORE USING THIS PRODUCT. SAVE THESE INSTRUCTIONS FOR FUTURE REFERENCE. FAILURE TO FOLLOW ALL INSTRUCTIONS, WARNINGS AND CAUTIONS MAY RESULT IN SERIOUS PERSONAL INJURY, PROPERTY DAMAGE AND/OR MAY VOID YOUR WARRANTY.

















SERVICE & IMPORTANT SAFEGUARDS

Service Information

 **WARNING:** Any repairs requiring disassembly should be performed by a Water Tech Authorized Service Center. For the repair center nearest you call us toll free at 1-800-298-8800.

 **WARNING:** To reduce the risk of fire, electrical shock, injury, or damage to your machine:

-  Do not use if unit is damaged in any way.
-  Use this product only for its intended use as described in this manual. Use only Water Tech accessories and filters.
-  Never leave your Pool Blaster plugged in for long term storage.
-  NEVER LEAVE YOUR Pool Blaster IN WATER WHEN IT IS “OFF” OR HAS RUN OUT OF BATTERY POWER.
-  Do not use your Pool Blaster for pool openings; the Pool Blaster is designed for general maintenance of your pool or spa.
-  The Pool Blaster is designed for underwater use only. Do not attempt to use your Pool Blaster to clean anything other than your pool or spa. It is not intended for use as an all-purpose vacuum cleaner.
-  Close supervision is necessary when used near children. Do not allow this vacuum cleaner to be used as a toy.
-  This vacuum creates suction. Keep hair, loose clothing, fingers, and all parts of body away from openings and moving parts.
-  Unit must be submerged in water to operate properly.
-  When not in use, store the Pool Blaster indoors in a clean, dry place. Do not leave underwater, in direct sunlight, or exposed to extreme temperatures.
-  You can operate the Pool Blaster without its vacuum head attachment, but when using the vacuum head attachment, make sure that either the supplied wheels or brushes are inserted in place.
-  Do not use without filter bag/seal ring and nose cap in place.
-  Replace damaged filter bag/seal ring promptly.
-  Avoid picking up hard, sharp objects with the vacuum. They may damage the vacuum and the filter bag.
-  Do not use to pick up toxic substances, flammable or combustible liquids such as gasoline, or operate in the presence of explosive or flammable fumes.

-  Never insert or drop any object into any opening on the device. Keep all openings free of leaves, rocks, or anything that may reduce water flow.
-  Do not use on or near hot surfaces.
-  Use extra care when cleaning on stairs.
-  Make sure the Pool Blaster is unplugged from the charger and in the “off” position before cleaning, filter change or any other routine maintenance.
-  While Pool Blaster is charging, do not handle with wet hands or without shoes.
-  Only use the charger supplied to recharge this vacuum. Do not use the supplied charger with any other appliance.
-  To protect against risk of electrical shock, do not put charger in water or other liquid.
-  To avoid damage to the charger and cord, never carry the charger by the cord or yank to disconnect from an outlet. Instead, firmly grasp the charger body and pull to disconnect. Do not pull cord around sharp edges or corners.
-  Do not allow the cord to hang over the edge of a table or counter or touch hot surfaces.
-  Do not operate with a damaged cord or charger.
-  Do not use or store charger outdoors. Charge your Pool Blaster indoors in a clean, dry place. Do not expose charger to rain, or extreme temperatures.
-  For best results, operate the charger in a location where the temperature is more than 50 degrees F but less than 100 degrees F.
-  Disconnect charger from power supply when not in use, and before any routine cleaning or maintenance.
-  The use of extension cords is not recommended. Plug the charger into a properly grounded standard electrical outlet (120v/60Hz US, 240 volts, 50Hz International) only.
-  If vacuum cleaner is not working as it should, or has been dropped or damaged in any way, return it to a service center before using. Call 1-800-298-8800 for a center nearest you.
-  This product contains a sealed nickel-metal hydride battery. Do not incinerate battery as it will explode at high temperatures. Always dispose of the battery in accordance with your state law.
-  Leaks from a battery cell can occur under extreme conditions. If the battery liquid gets on the skin, wash immediately with water. If it gets in your eyes, immediately flush your eyes with a mild solution of baking soda and water and seek medical attention.

Important Safeguards

Product Specifications

HANDVAC	BATTERY
Motor 7.2 Volt, DC	Charger Rating 120V, 60 Hz AC only (US) 240 volts. 50Hz AC only (International)
Switch On-Off	Charger Voltage 8.4 Volt

ITEM No.	DESCRIPTION	PART No.	QTY.
1	Vacuum Head	PBA006	1
2	Vacuum Head Brushes (for vinyl pools)	PBW049	8
3	Vacuum Head Wheels (for gunite pools)	PBW050	5
4	Nose Cap	PBA002	1
5	All Purpose Filter Bag/Seal Ring	PBW022AP	1
6	Pool Blaster	PBA005	1
7	Battery Charger	PBA099*	1
8	Spring Clip	PBW041	1

ADDITIONAL PARTS:

Sand & Silt bag (part No. PBW022SS)

Microfilter Bag (part No. PBW022MF), to be used in conjunction with Sand & Silt bag

Shallow Water Hose Attachment (part No. PBASHA)

* U.S. Charger (part No. PBA099)

* European 230V Charger (part No. WT3843)

To purchase, contact your retailer or call us at (800)298-8800

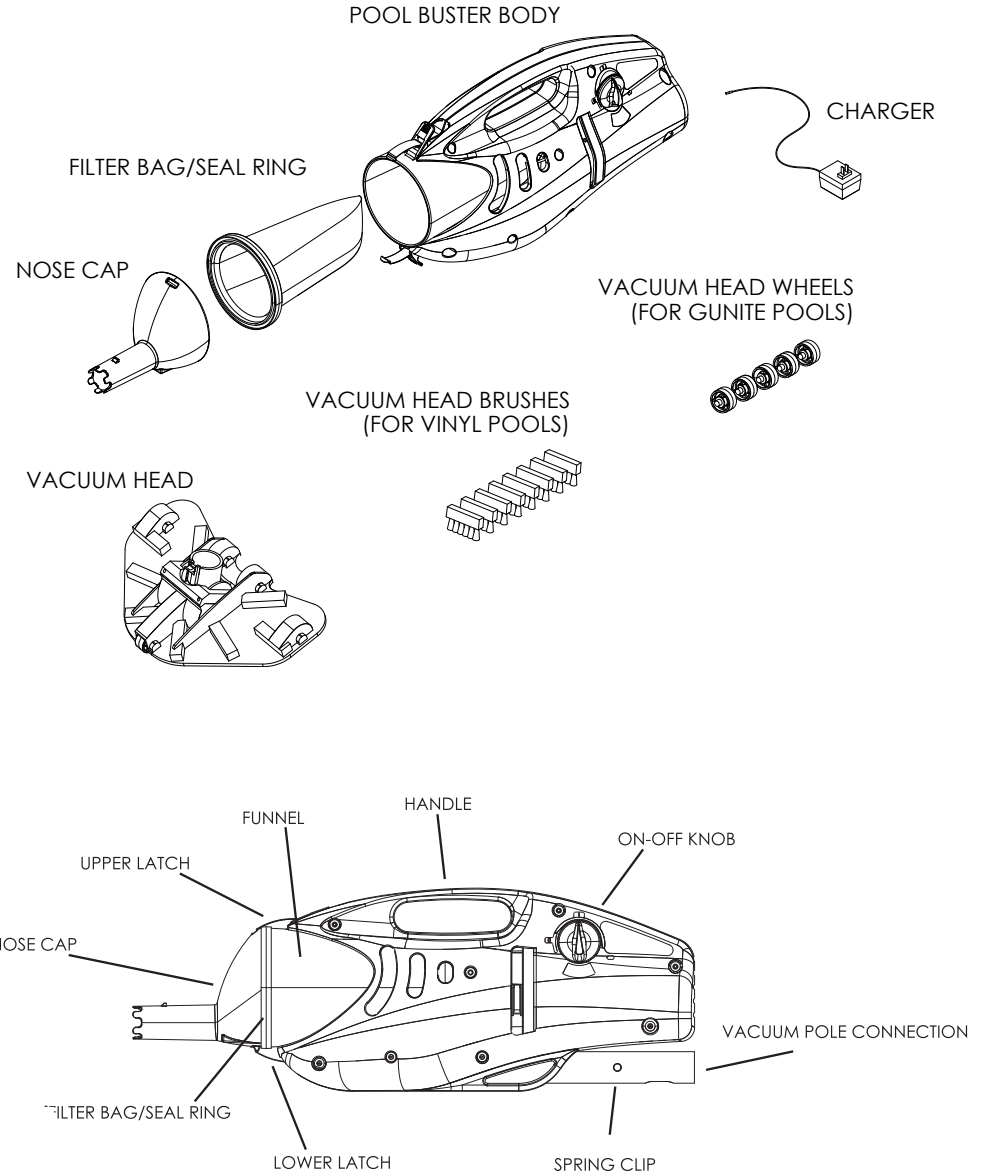

CHARGING YOUR POOL BLASTER

The battery pack for your Pool Blaster has been shipped in a low voltage condition. It should be charged overnight prior to use.

WARNING: The Pool Blaster charger is for indoor use only.

WARNING: Do not expose charger to excessive moisture or extreme heat or cold. Charge battery only with the battery charger provided.

PRECAUTIONS:

- Make sure power supply is normal household voltage, 120 volts, 60 Hz (240 volts, 50Hz International), AC only.
- Do not handle Pool Blaster while charging with wet hands or without shoes.
- Do not use or store your charger outdoors. Charge battery indoors in a clean dry place. For best results, your Pool Blaster battery should be charged in a location where the temperature is above 50 degrees F and below 100 degrees F.
- Only use the charger supplied to recharge this vacuum. Do not use the supplied charger with any other appliance or damage may occur.
- Disconnect Pool Blaster from power charger when not in use.
- Unplug the charger from outlet before any routine cleaning or maintenance.
- The use of extension cords is not recommended. Plug the charger into a properly grounded standard electrical outlet (120v/60Hz US, 240 volts, 50Hz International) only.
- To protect against risk of electrical shock, do not put unit charger in water or other liquid.
- To avoid damage to the charger and cord, never carry the charger by the cord or yank to disconnect from an outlet. Instead, firmly grasp the charger body and pull to disconnect. Do not pull cord around sharp edges or corners.
- Do not allow the cord to hang over the edge of a table or counter or touch hot surfaces. The vacuum should be placed or mounted away from such hot surfaces.

TO CHARGE

- Turn the knob counterclockwise to remove the On-Off Knob. This will expose the charging jack connection. NOTE: When removing the On-Off knob it is normal to hear air escaping. The air inside has simply expanded from being heated by the motor.
- Connect the lead from the charger to the charging jack on the Pool Blaster.
- Connect the charger to the appropriate electrical outlet.
- After charging, ensure that the On-Off knob is fully secure and turned to the “On” position before attempting to use your Pool Blaster.

CAUTION: Replace On-Off knob after charging. Placing Pool Blaster in water without replacing the knob will void your warranty.

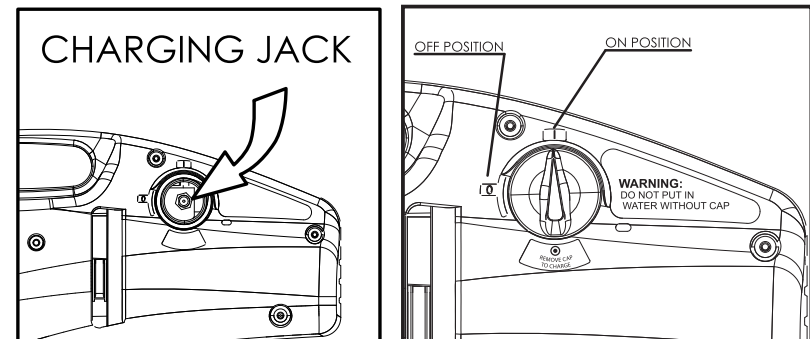

BATTERY LIFE

- The batteries are factory sealed in the motor box, and CANNOT BE REPLACED. Do not attempt in any way to destroy or disassemble motor box or any of its components. Under no circumstances should you attempt to open the battery pack and replace the batteries yourself. Your battery pack should give you many hours of use. If your motor, batteries, or charger stop working, take the Pool Blaster to an authorized service center.
- NEVER LEAVE your Pool Blaster plugged in for long term storage.

After charging, the On-Off knob should remain disconnected from the unit and left hanging from the attached lanyard.

SETTING UP YOUR POOL BLASTER FOR USE

Your Pool Blaster has a unique patented vacuum head that can be adapted to use on all types of pool surfaces. We recommend the following:

- For gunite, we recommend using the five (5) wheels (part no.PBW050) which came with your Pool Blaster. The five wheels are inserted into the vacuum head (part no.PBA006), as shown in the diagram. To prevent damage to your pool, ensure all five (5) wheels are fully inserted into the vacuum head before you begin use. NOTE: Inserting the wheels into the vacuum head may require a good deal of force. If you have trouble, you may find it easier to insert them by placing on a hard surface and pushing down on the head.
- For vinyl liner and fiberglass pools we recommend using the eight (8) brushes (part no.PBW049) which came with your Pool Blaster. The eight (8) brushes are inserted into the vacuum head (part no.PBA006), as shown in the diagram. To prevent damage to your pool, ensure all eight (8) brushes are fully inserted into the vacuum head before you begin use.

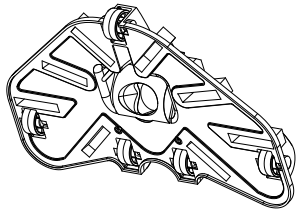

INSERT WHEELS FOR GUNITE POOLS

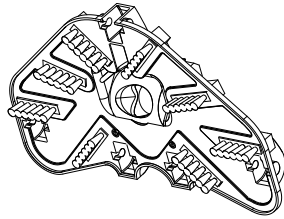

INSERT BRUSHES FOR VINYL POOLS

Note: Wheels OR Brushes must be installed prior to use. Water Tech is NOT responsible for damages to your pool if neither the wheels nor brushes are installed in the vacuum head before use.

CAUTION: Do not use the Pool Blaster vacuum head without either the supplied wheels or brushes inserted.

INSERTING THE FILTER BAG

Please follow these instructions carefully:

- Place the Pool Blaster on its end on a stable and secure surface.
- Place the filter bag/seal ring (part no.PBW022AP) into the Pool Blaster, as shown in diagram. Make sure the rubber seal ring sits on the funnel. All of the filter bag must be inside the funnel to ensure the head closes fully.
- Put the nose cap (part no.PBA002) on the funnel, as shown. Align the nose slots with the upper and lower latch on the Pool Blaster.
- Close the upper and lower latch together squeezing the filter bag/seal ring in between.

NOTE: You should not need to apply excessive force in order to close the latch. If you have trouble, make sure the filter bag is not between the seal and the nose cap or funnel and there are no other obstructions such as sand.

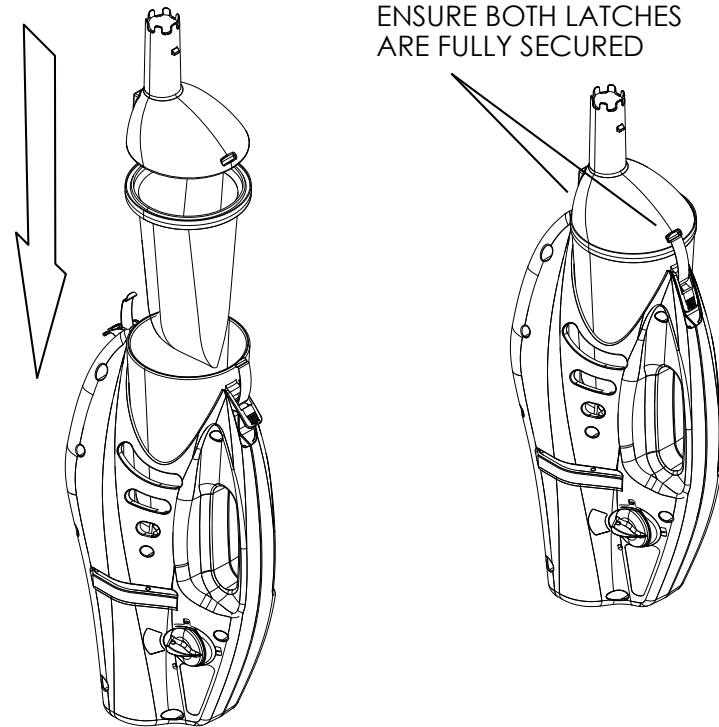

HOW TO USE YOUR POOL BLASTER

⚠ CAUTION: The Pool Blaster is designed for underwater use only. Do not attempt to use your Pool Blaster to clean anything other than your pool or spa. It is not intended for use as an all-purpose vacuum cleaner. Unit must be submerged in water to operate properly. Maximum operating temperature is between +5DEGC (41°F) and +40DEGC (104°F). Maximum operating depth is 4 meters (15 ft)

- Close supervision is necessary when used near children. Do not allow this vacuum cleaner to be used as a toy.
- This vacuum creates suction. Keep hair, loose clothing, fingers, and all parts of body away from openings and moving parts.
- The Pool Blaster can be used without the head attachment. However, when using the head attachment, be sure that either supplied wheels or brushes are inserted in place.
- Avoid picking up hard, sharp objects with the vacuum. They may damage the vacuum and the filter bag.
- Do not use without filter bag/seal ring and nose cap in place.
- Replace damaged filter bag/seal ring promptly.
- Do not use your Pool Blaster to pick up toxic substances, flammable or combustible liquids such as gasoline, or operate in the presence of explosive or flammable fumes.
- Never insert or drop any object into any opening on the device. Do not use with any opening blocked. Keep all openings free of leaves, rocks, or anything that may reduce water flow.
- Do not use on or near hot surfaces.
- Use extra care when cleaning on stairs.
- When not in use, store the Pool Blaster indoors in a clean, dry place. Do not leave in direct sunlight, underwater, or exposed to extreme temperatures.

Your Pool Blaster is designed for use in 3 different ways to vacuum your pool or spa:

- A. Vacuum using the handle and the vacuum head removed.
- B. Vacuum using the handle and attached vacuum head, with either wheel or brush attachments depending on pool type.
- C. Vacuum using a standard vacuum pole (not supplied) with the attached vacuum head.

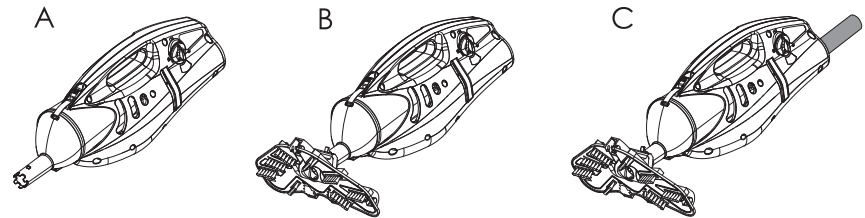

⚠ WARNING: Never use your Pool Blaster without the filter bag/seal ring and nose cap properly in place. Doing so will VOID the warranty.

Using a standard pole

The pole attachment on your Pool Blaster is designed to accommodate any standard pole. To attach a pole, simply press down on the alignment pins on the pole retaining spring clip. Aligning the holes, slide the pole onto the Pool Blaster and release the clip.

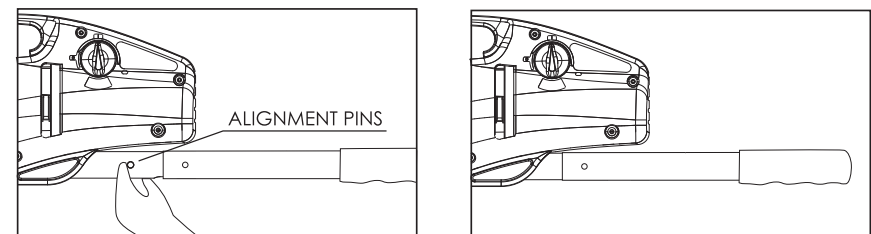

⚠ WARNING: Do not lean on pole or use pole to support weight.

HOW TO USE YOUR POOL BLASTER

⚠ WARNING: Never put the Pool Blaster in water while the charging jack is connected.

⚠ WARNING: To keep water out of the motor box, before submerging make sure the On/Off knob is fully secured by turning all the way until it stops at a 12 o'clock position.

Once your Pool Blaster is set-up for use, you may put it in your pool or spa.

- Bring your Pool Blaster to the side of the Pool or Spa and turn it on by turning the On-Off knob all the way to the "On" position. This must be done outside of the water before it is submerged.
- Once the Pool Blaster is "On" it can be completely submerged in water and is ready for use.
- This appliance is designed to be in water only when in the "ON" position and has battery power. Excessive leaking can occur when not running and void the warranty. Never leave your Pool Blaster in the water when it is off.

⚠ WARNING: If any parts are missing, do not operate until the missing parts are replaced. Failure to do so could result in serious injury.

NOTE: There are two ways to remove the unit from the pool:

1. WHEN USING HANDLE: Lift from pool with the nose facing up to allow the water to escape from the back and sides.
2. WHEN USING A VACUUM POLE: Remove the unit from the pool with the bottom facing upwards and the handle facing down. This will allow the water to escape and keep the dirt inside

NOTE: The cleaner is only designed to vacuum water and will not vacuum air. The cleaner will only work when completely submerged in water and the air is out of the clear funnel.

⚠ WARNING: Opening the "ON-OFF" knob exposes the motor components, never let water enter the hole as this will ruin your appliance and void the warranty.

Cleaning the reusable filter bag

For maximum cleaning efficiency the filter bag/seal ring should be checked, emptied, and cleaned after each use or whenever you notice the performance of you Pool Blaster declining.

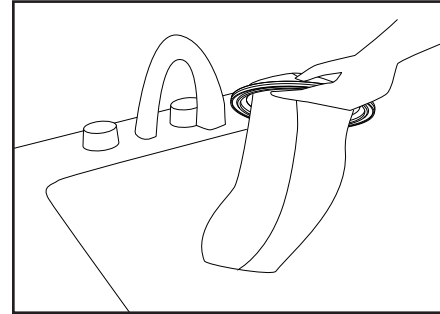

⚠ WARNING: Using your Pool Blaster without the filter bag/seal ring in place will VOID your warranty.

To clean the filter bag/seal ring

- Unplug the Pool Blaster from the charging outlet before changing the filter or performing any other routine maintenance.
- Place the Pool Blaster on its end (remove the vacuum pole, if attached).
- Unlatch the upper and lower latch together (see diagram).
- Remove the filter bag/seal ring by pulling it out of the funnel (see diagram).
- Invert the filter bag/seal ring and rinse with a garden hose or in a sink. Note: do not clean in a washing machine or with detergent.
- Re-insert the filter bag when finished.
- Note: Your reusable filter bag should be replaced if the seal ring is worn or if the bag is torn.

⚠ WARNING: Keep away from children. Failure to comply with these warnings could result in fire and/or serious injury.

⚠ WARNING: When servicing user serviceable parts, use only identical Water Tech replacement parts. Use of any other parts may create a hazard or cause product damage.

MAINTENANCE

Important Tips:

- Store your Pool Blaster in a clean, dry place when not in use. Do not leave it under-water, in direct sunlight, or exposed to extreme heat or cold.
- You may clean the Pool Blaster body with soap and water. Avoid using solvents when cleaning plastic parts. Most plastics are susceptible to damage from various types of commercial solvents and may be damaged by their use. Use clean cloths to remove dirt, dust, oil, grease etc.
- The On-Off knob should be periodically lubricated with a silicon-based grease.

 **CAUTION:** Do not at any time let brake fluids, gasoline, petroleum-based products, penetrating oils, etc. come in contact with plastic parts. They contain chemicals that can damage, weaken, or destroy plastic.

 **WARNING:** Do not attempt to modify this tool or create accessories not approved for use with this tool. Any such alteration or modification is misuse and could result in a hazardous condition leading to possible serious injury. The batteries and motor are factory sealed in the motor box, and CANNOT BE REPLACED. Do not attempt in any way to destroy or disassemble motor box or any of its components. Instead, take your Pool Blaster to an authorized service center. Failure to follow these instructions may void your warranty agreement.

- General maintenance of your Pool Blaster requires you occasionally clean off the O-rings on the "ON-OFF" knob and add silicone lubricant/sealant. This will ensure easier turning and a water-tight seal. This lubricant is available at your local pool & spa retailer.
- In the Nose Cap (Part No. PBA002) there is a Flapper Valve. To keep the Nose Cap Flapper Valve moving freely, clean the valve after every use. This will help to keep dirt inside the Pool Blaster after the cleaner is removed from the pool.

Service Information

NOTE: Any repairs requiring disassembly must be performed by a Water Tech Authorized Service Center. For the repair center nearest you call us toll free at 1-800-298-8800. Unauthorized repairs will void the warranty.

Storing the Pool Blaster

NOTE: State of the art Nickel-Metal Hydride batteries power the Pool Blaster. These are the same batteries used in many portable phones. In order to properly ventilate and cool the batteries and drive system a certain amount of space is left open in the Pool Blaster body. As a result, from time to time, water may enter the unit. In order to allow for any water to be drained you should remove the On-Off Knob after each use, turn the machine so the knob is towards the floor and tilt side to side in all directions. The amount of water may be very small or not noticed at all. After removing any water use a blow dryer on warm setting to dry any moisture build-up on the inside of the motor box. Water entering the Pool Blaster body presents no safety hazard and should be drained to avoid any chance of long-term corrosion. . The batteries and motor in the Pool Blaster are long lasting and proper care will help to prolong the life of your appliance.

NOTE: Remove Pool Blaster from charger before storage.

When not in use, your Pool Blaster should be stored indoors, in a clean dry location sheltered from direct sunlight, extreme temperatures and rain. Do not store the Pool Blaster in a garage or anywhere the unit could freeze. Storing the Pool Blaster in areas of high humidity can affect battery performance over time.

For your convenience the Pool Blaster has an oval opening in the pool pole adaptor on which you can hang the unit.

Long Term Storage

Follow the above storage instructions and unplug the charger from the electrical outlet.

When charging for the first time after long-term storage, your Pool Blaster may take 2-3 uses before full time is achieved.

WARRANTY

Water Tech warrants this product for one year against any defects in material or workmanship under normal use and service, subject to conditions and limitations as described below.

Parts not covered under warranty: The filter bag, nose cap, vacuum head, wheels and brushes are not warranted parts as these items require replacement in the normal course of use, due to normal wear.

This warranty covers only normal use for a residential swimming pool or spa. Damage, defect, malfunctions or any use, which does not comply with the operator instructions, are excluded. Damage or any failure caused by repair, which is done by anyone other than a Water Tech authorized service center, shall not be covered.

The motor housing is a factory sealed unit. The warranty will be considered void if opened by a non-authorized service center.

To validate this warranty: The enclosed WARRANTY REGISTRATION CARD must be mailed within ten days of purchase. No warrant service will be performed unless Water Tech has received the WARRANTY REGISTRATION CARD.

The warranty obligations of Water Tech shall be limited to repair or replacement of the product. Water Tech, Inc shall not be liable or responsible under any circumstances or in any amount for consequential or incidental damages, or for injury or damages to persons or property using or used in connection with the product or for loss of profits or other costs or expenses of any kind of character. There are no other warranties or representations by Water Tech other than as set forth herein, either expressed or implied and no person, firm or corporation is authorized to make any representation or incur any obligation in the name or on behalf of Water Tech except as stated herein.

COMMON QUESTIONS

Q: The ON-OFF knob has become difficult to turn. What can I do?

A: Clean off the O-rings and add silicone lubricant/sealant. This will ensure easier turning and a better water tight seal. Refer to the maintenance section for more information.

Q: Can my Pool Blaster be run out of water?

A: Yes, for a short period of time when you turn it on before submerging into your pool or spa.

Q: When I am cleaning my pool how do I know when the Pool Blaster is out of battery power?

A: Most people can feel the Pool Blaster is running through vibration in the vacuum pole or handle. To be sure you can lift it out of the water to hear if it is running or not.

Q: How often should I clean out my Pool Blaster filter bag?

A: You can clean your filter bag as often as you like with no ill effects. The filter bag can then be turned inside out and rinsed with a hose or in a sink. Do not wash it in a washing machine or with detergent. For more detailed instructions, see "Cleaning Your Pool Blaster" instructions in this manual.

For best results, do this after each use, or whenever you notice the performance of your Pool Blaster declining.

Q: Is it normal for me to hear air escaping out of the Pool Blaster when I open the On-Off knob?

A: Yes, the powerful motors heat the air in the motor box, which then expands, creating the air sound.

Q: How can I stop dirt from coming out of the nozzle when I take the cleaner out of the water?

A: There are two ways to remove the unit from the pool when done cleaning:
WHEN USING HANDLE: Lift from pool with the nose facing up to allow the water to escape from the back and sides.
WHEN USING A VACUUM POLE: Remove the unit from the pool with the bottom facing upwards and the handle facing down. This will allow the water to escape and keep the dirt inside.

Q: How can I Prevent sand and silt from escaping through the filter bag?

A: The Pool Blaster comes standard with an all-purpose filter bag. A Sand and Silt bag (Part No. PBW022SS) is available. To purchase contact your retailer or call us at 1-800-298-8800.

Q: What if I put the Pool Blaster in the pool without the On-Off Knob in place?

A: Do not operate your Pool Blaster if water gets inside the machine. Put the Pool Blaster on its side to drain the water out of the knob hole and tilt side to side to get the water out. Do not use for at least 24 hours. If possible, you can speed the drying process with a blow dryer. To avoid

serious injury or damage, do not replace the knob or attempt to charge or operate your Pool Blaster until it is completely dry.

Q: Can I leave my Pool Blaster on the charger all the time?

A: After charging is complete, the Pool Blaster and charger should be removed from the outlet. This will prevent overcharging and prolong the life of your battery pack. IMPORTANT: Disconnect the charger before storing your Pool Blaster.

Q: Can I replace the batteries myself?

A: Under no circumstances should you attempt to open the motor housing or battery housing. The batteries and motor are factory installed and sealed, and your rechargeable battery should give you many hours of use. If your motor, batteries, or charger stop working, take the Pool Blaster to an authorized service center.

Q: Where can I buy replacement parts?

A: Look for original Water Tech replacement parts at your local retailer or call 1-800-298-8800 for more details.

Q: Will my pool chemicals hurt the Pool Blaster?

A: The Pool Blaster is designed to withstand pool chemicals during its usage period. However, it should be rinsed off with fresh water after it is removed from the pool. This will increase the life of the filter bag/seal ring.

Q: Can I leave the Pool Blaster in the pool when not in use?

A: No. The Pool Blaster should be removed from the pool and stored in a clean, dry place when not in use. This will increase the life of your Pool Blaster and its accessories.

Q: What do I do if my Pool Blaster does not vacuum?

A: Make sure your Pool Blaster is completely submerged in the water and the air is out of the clear funnel. The cleaner is only designed to vacuum water and will not vacuum air.
If that does not resolve your situation please check the following:

- Make sure the filter bag is clear of debris that may be obstructing the flow.
- Make sure the Pool Blaster is in the 12 o'clock "ON" position.
- Charge your Pool Blaster for at least 24 hours.

**If none of the above help resolve the situation,
please call our Customer Service Division at 1-800-298-8800.**